

60" Straight Desk w/24" Shelves

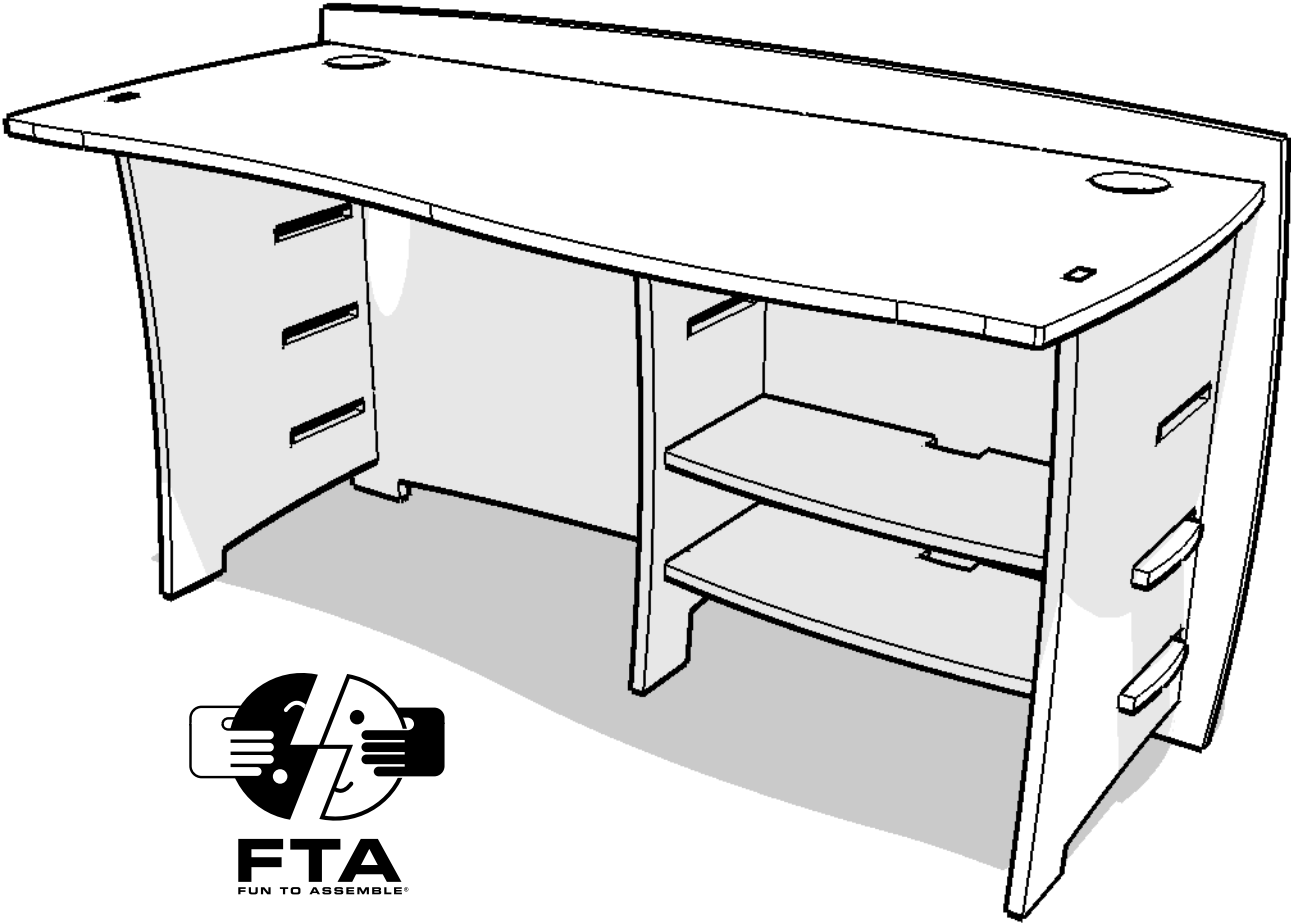

Assembly

1

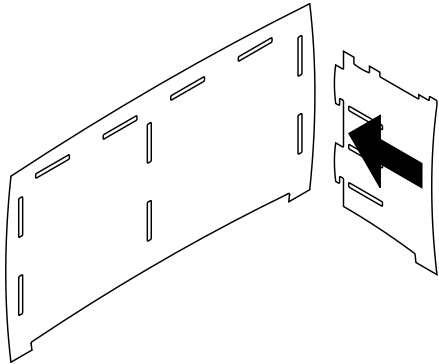

2

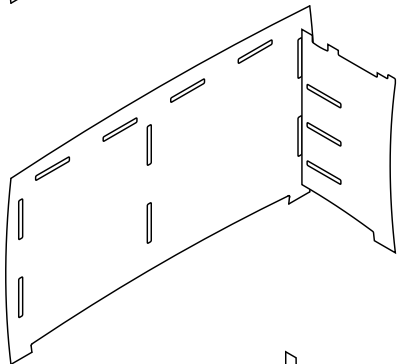

3

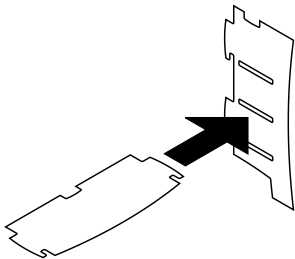

4

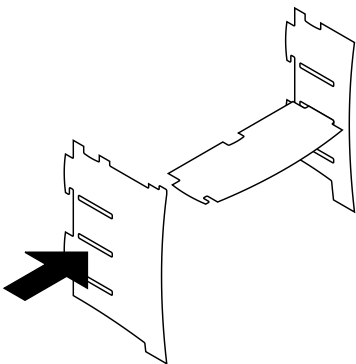

5

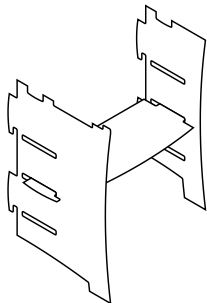

6

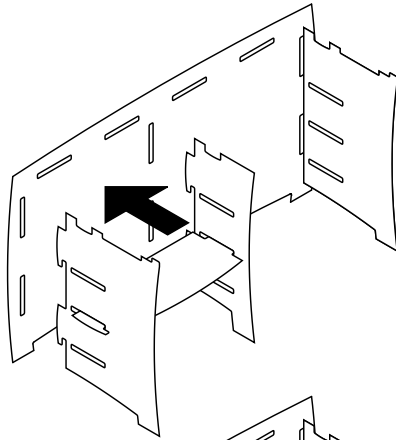

7

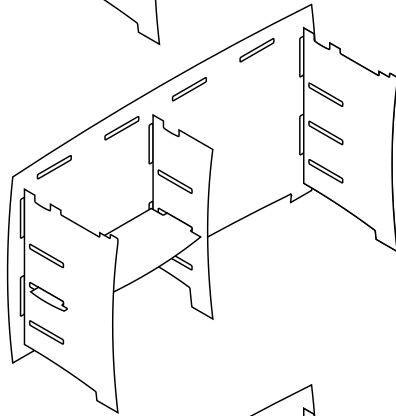

8

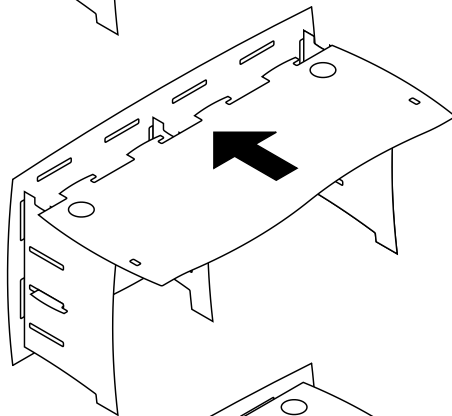

9

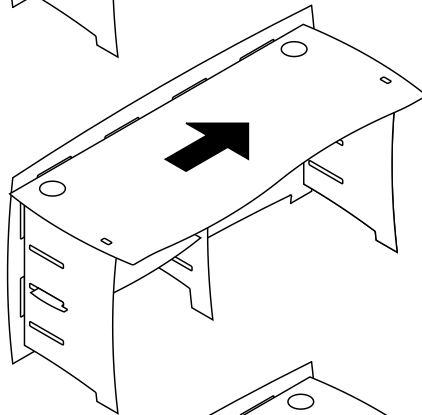

10

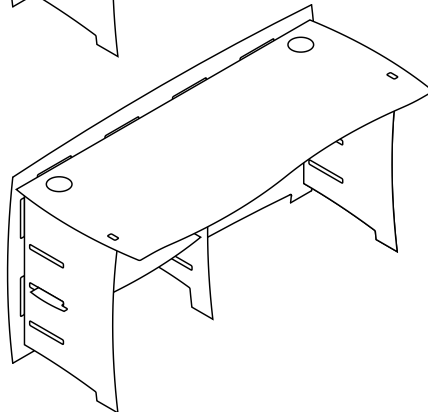

Care & Finishing

Thank you for the purchase of your new Legaré product. We certainly hope that it serves you well for many years to come.

Depending upon the finish of your particular components, there are few things that you should do to protect its finish or to insure that the finish that you put on it does not cause you any problems.

Pre-Finished Parts

Parts finished with a lacquer finish require little more than a light coat of lemon oil or furniture polish to make assembly easier and preserve the finish. Doing this before assembling the parts will prevent chafing and will make the parts easier to slide together. There is one exception, though. The small connector that locks a peninsula, extension or bridge to a desk should be a very snug fit in order to hold the units together more rigidly.

Before putting any heavy objects with plastic or rubber feet on the work surface, you should be aware that some materials can discolor the finishes on furniture. Plastics will release plasticizers which can penetrate and stain some finishes. If your equipment has black plastic or rubber feet, put something between the equipment and the work surface to protect the finish. Applying a coat of furniture polish or wax can help in many cases, but will not always eliminate the problem. A pad or mat between the desk surface and the item is the best solution.

Un-Finished Parts

When finishing Legaré furniture yourself, the most important thing to consider is the build-up of any finish that you put on the parts. The Legaré panels are designed with some clearance between the tabs and slots in order to accommodate the build-up of a lacquer finish. If you intend to simply stain your parts, you should not have any problems. However, if you intend to add a sealer or a thick coat of urethane or lacquer, you need to consider the thickness that these finishes can add to the parts. You may need to sand the tabs and slots further if your build-up will exceed 5 or 6 mil (.005"-.006") per side to insure that the panels will still fit together properly.

When doing any sanding, remember that not all edges are critical. You can save yourself a good amount of labor by not spending excessive time sanding and preparing edges that you will not see or touch. Also, if you intend to put on a sealer, it is not necessary to sand the surfaces to a mirror finish as the sealer will tend to fill in the surface roughness of the material. And, remember that the small connector that locks a peninsula, extension or bridge to a desk should be a snug fit, so don't sand too much off of its edges.

If you should need to touch up any gouges or scratches, you can use a small amount of wood dough the color of your final finish. Should any splinters occur along an edge, simply use normal wood glue to re-bond a splinter. And should you need to touch up any edges, use a small trim router with a 3/16" radius round-over bit.

And remember, because Legaré is a natural wood product, the resulting finish may vary from piece to piece whether the parts come pre-finished or you finish them yourself.

Contents

